

# DC-ATCO

Direct Current Thermal-Link (Alloy Type)

TGH Series

## Description

The Direct Current Thermal-Link Alloy Type (DC-ATCO) is a thermal-link that utilizes low melting point alloys, known as the thermal element, which fuse when heated to a specific fusing temperature. This allows for controlled circuit disconnection. The DC-ATCO is composed of various components, including electrode leads, a case, the low melting point alloys (thermal element), flux resin, a fuse, filler material, and sealant. The DC-ATCO is widely employed for over-temperature protection in electrical equipment and electric vehicles. Typically, the low melting point alloys (thermal element) are connected in series between two electrode pins. When the temperature reaches the predetermined fusing temperature of the DC-ATCO, the low melting point alloys (thermal element) melt and swiftly retract to the ends of the two pins, facilitated by the flux resin. This effectively disconnects the circuit.

The SETsafe | SETfuse Direct Current Thermal-Link (Alloy Type) is available in axial and radial shapes, with a Rated Functioning Temperature ranging from 102 °C to 187 °C, Rated Current 15 A, Rated Voltage 850 VDC. It is compliant with RoHS and REACH regulations.



## Marking

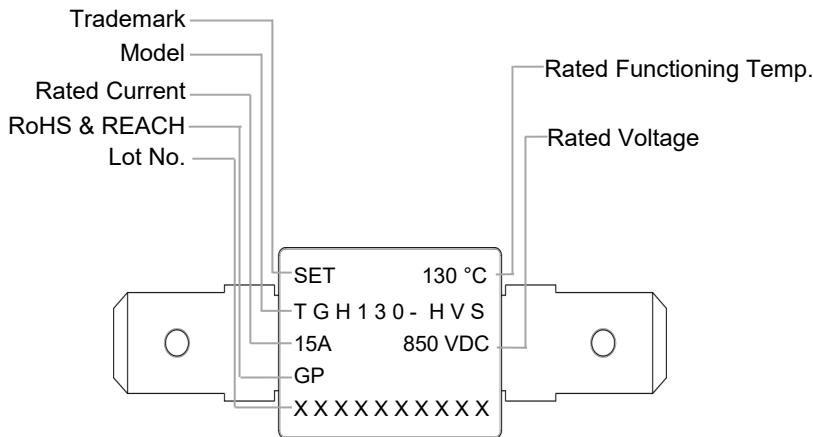

## Structure Diagram

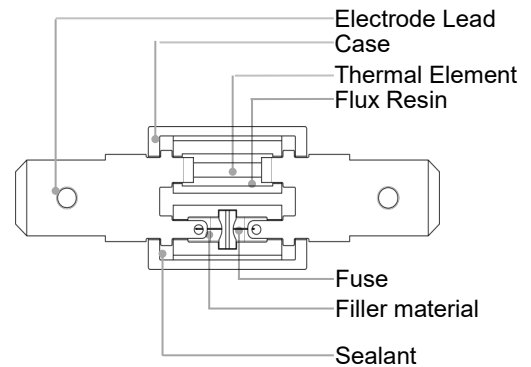

## Product Schematic

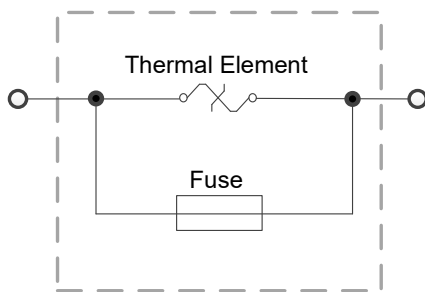

## Features

- 0 to 850 VDC Operating Voltage
- High Accuracy of Functioning Temp.
- Ceramic Case
- Non-Resettable
- RoHS & REACH Compliant

## Applications

- Battery Cooling Heaters
- Air-Conditioners Heaters
- Pre-charged Resistors
- High Power LED

## Customization

- Rated Functioning Temp.
- The Shape of Electrode

# DC-ATCO

Direct Current Thermal-Link (Alloy Type)

TGH Series

## Part Number System

TGH130 - H V S

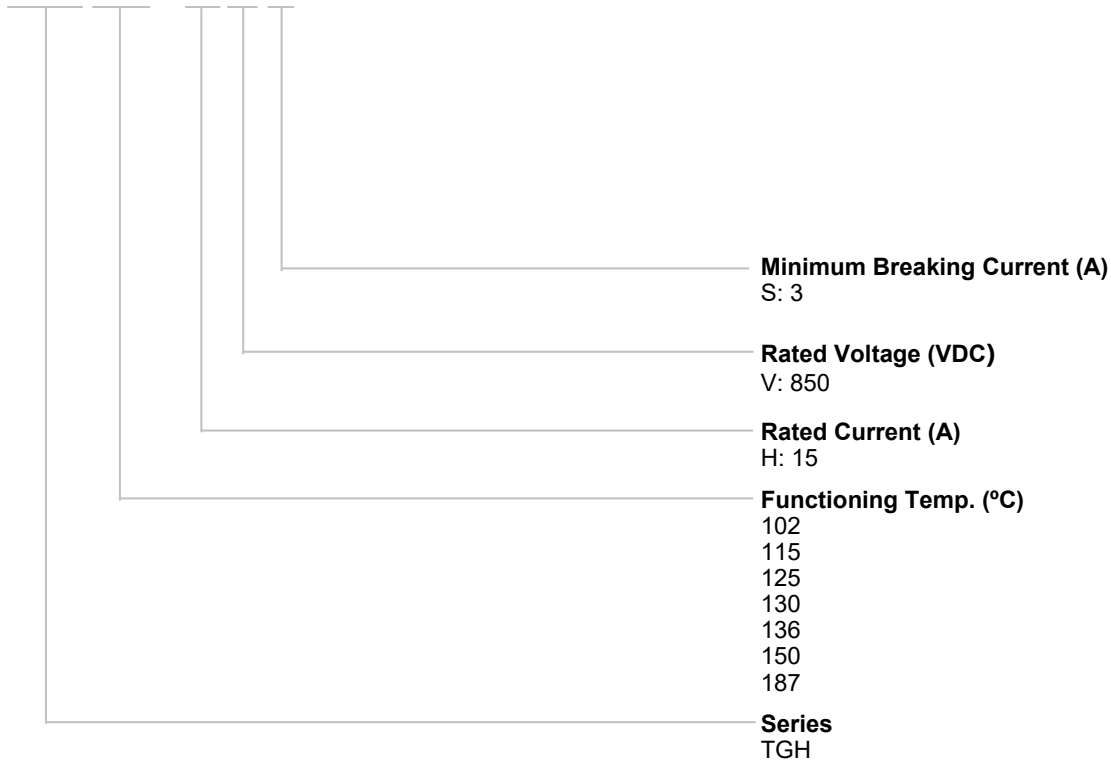

### Reminder:

Part numbering system in the datasheet is only for selecting correct parameter and product features. Before placing order, please contact us for specifications and use the part number and product code in the specifications to place order to ensure the part is correct. Product code is the unique identification.

DC-ATCO

Direct Current Thermal-Link (Alloy Type)

TGH Series

Dimensions (Unit: mm)

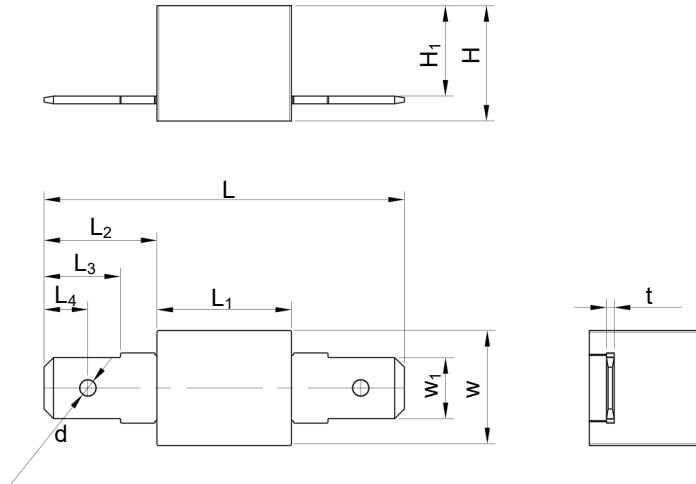

L	L <sub>1</sub>	L <sub>2</sub>	L <sub>3</sub>	L <sub>4</sub>	W	W <sub>1</sub>	H	H <sub>1</sub>	t	d
37.5 ± 2.0	14.0 ± 1.0	11.75 ± 0.30	7.95 ± 0.30	4.55 ± 0.2	12.0 ± 1.0	6.35 ± 0.20	12.0 <sup>+0.5</sup> <sub>-0.0</sub>	9.4	0.80 ± 0.05	1.65 ± 0.20

Specifications

Rated Functioning Temp. (T<sub>f</sub>) °C

	Model	I <sub>r</sub>	U <sub>r</sub>	Rated Functioning Temp.	T <sub>h</sub>	T <sub>m</sub>	I <sub>min</sub>	RoHS REACH
		(A)	DC (V)	(°C)	(°C)	(°C)	(A)	
187	TGH187-HVS	15	850	182 <sup>+5</sup> <sub>-3</sub>	155	250	3	●
150	TGH150-HVS	15	850	146 ± 3	105	250	3	●
136	TGH136-HVS	15	850	131 ± 3	95	250	3	●
130	TGH130-HVS	15	850	126 ± 3	90	250	3	●
125	TGH125-HVS	15	850	122 ± 3	75	250	3	●
115	TGH115-HVS	15	850	112 ± 3	65	250	3	●
102	TGH102-HVS	15	850	99 <sup>+5</sup> <sub>-3</sub>	63	250	3	●

Note:  
1. RoHS & REACH Comply.

### Temp.-Time Curve

The functioning temperature time curve of Alloy Thermal-Link in different Temp. oil bath (For reference only).

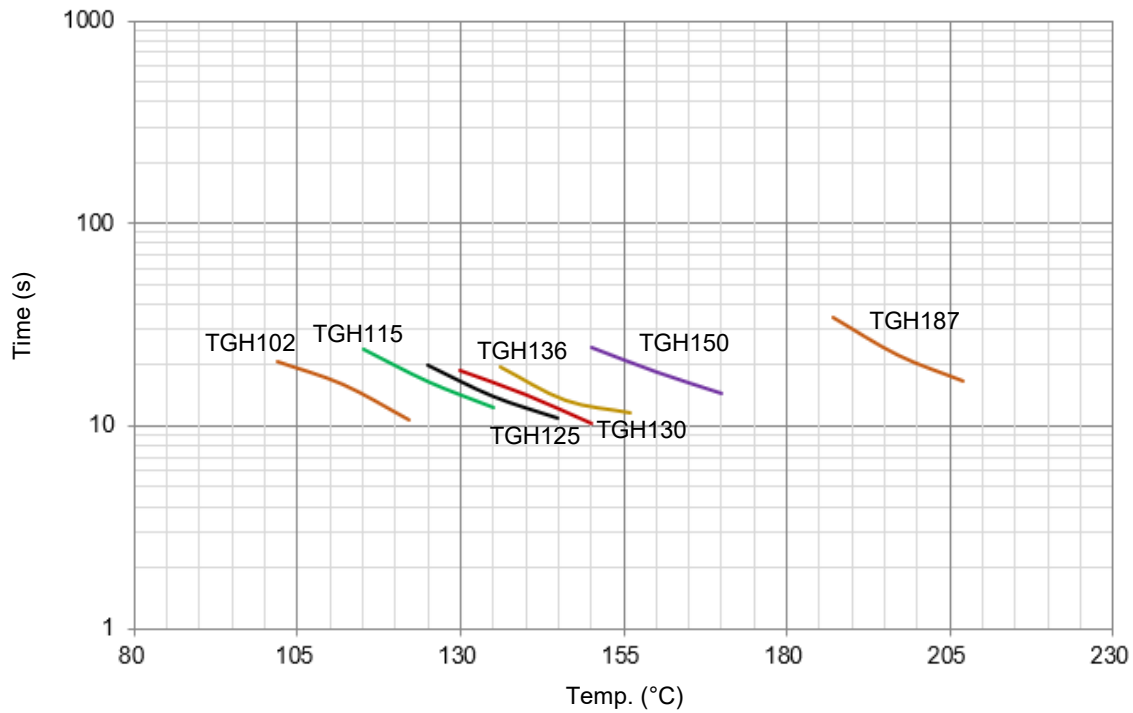

### Current-Time Curve

This is an illustrated curve, describing the opening time at Multi-times rated current in the condition of the room Temp. 25 °C (For reference only).

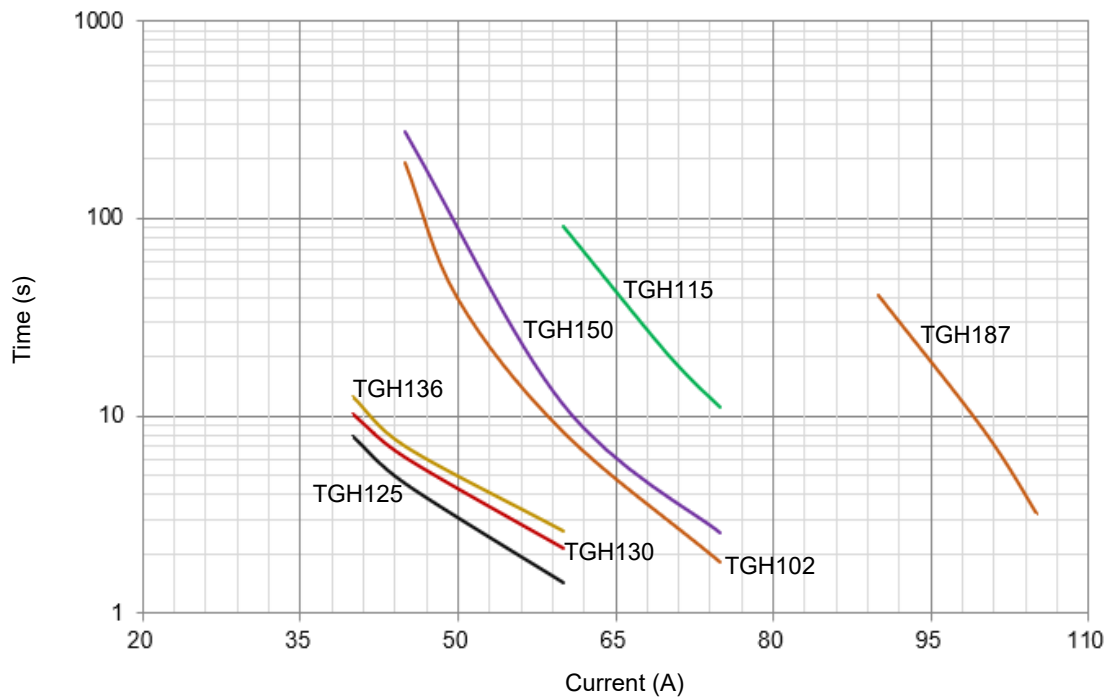

**Packaging Information**

Item	Tray	PE Bag	Carton
Dimensions (mm)	320 x 214 x 18	322 x 216 x 82	435 x 345 x 245
Quantity (PCS)	36	180	1080
Gross Weight (kg)			10 ± 10%

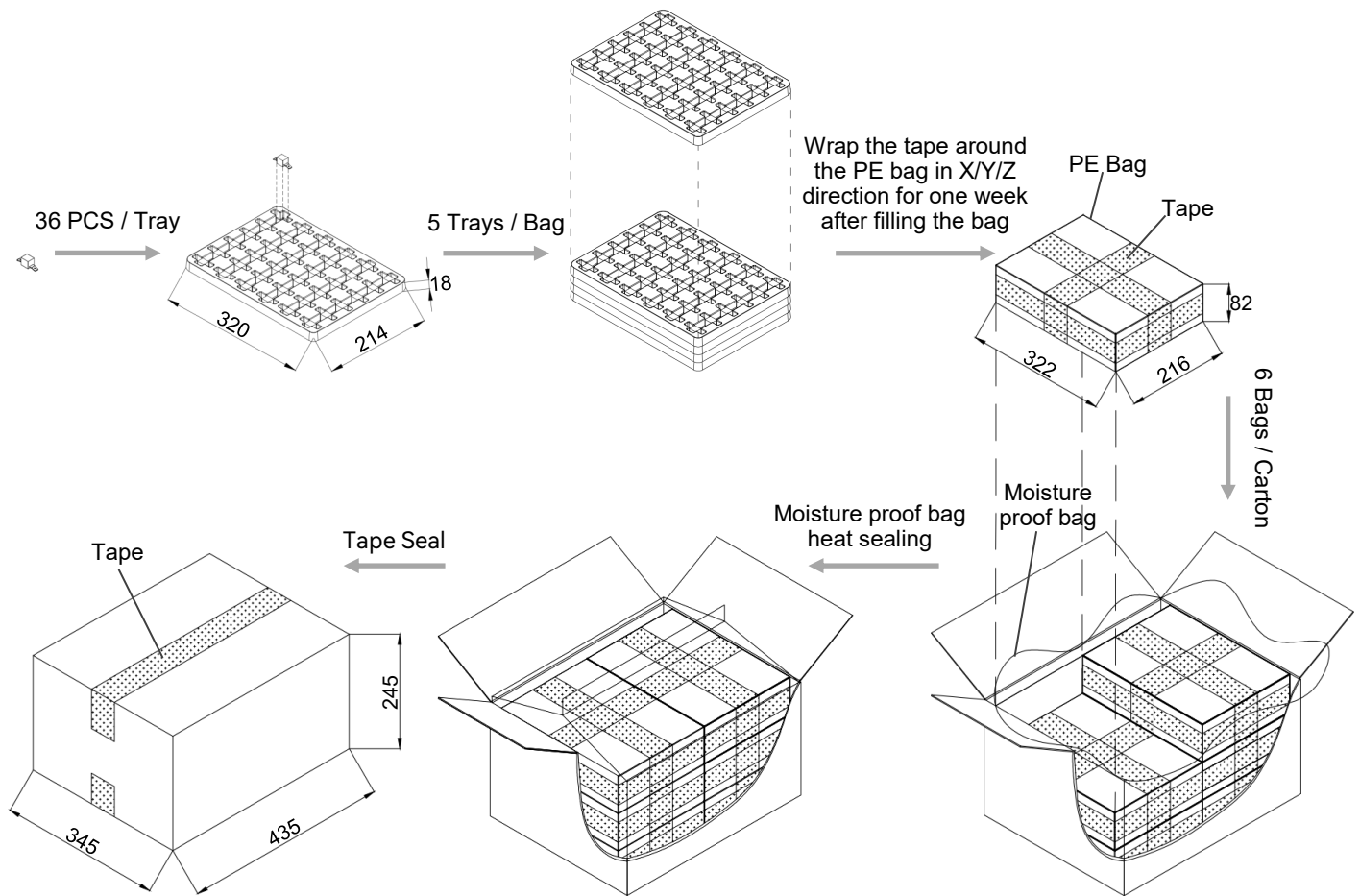

## Glossary

Item	Description
DC-ATCO	<b>DC-Alloy Thermal-Link</b> DC-Alloy type Thermal-Link, Alloy is thermal element.
$T_f$	<b>Rated Functioning Temp.</b> The temperature of the Thermal-Link which causes it to change the state of conductivity with a detection current up to 10 mA as the only load. Tolerance: $T_f$ (0 / -10) °C (GB 9816, EN 60691, K60691). Tolerance: $T_f \pm 7$ °C (J60691).
<b>Fusing Temp.</b>	<b>Fusing Temp.</b> The temperature of the Alloy Thermal-Link which causes it to change its state of conductivity is measured with silicone oil bath in which the temperature is increased at the rate of 0.5 °C to 1 °C / minute, with a detection current up to 10 mA as the only load.
$T_h$	<b>Holding Temp.</b> The Maximum temperature at which a Thermal-Link will not change its state of conductivity when conducting rated current for 168 hours.
$T_m$	<b>Maximum Temp. Limit</b> The temperature of the Thermal-Link stated by the manufacturer, up to which the mechanical and electrical properties of the Thermal-Link having changed its state of conductivity, will not be impaired for a given time.
$I_{min}$	<b>Minimum Breaking Current</b> The minimum current that Fuse requires after the Alloy of Thermal-Link opens in the circuit.
$I_r$	<b>Rated Current</b> The current used to classify a Thermal-Link, which is the maximum current that Thermal-Link allows to carry and is able to cut off the circuit safely.
$U_r$	<b>Rated Voltage</b> The voltage used to classify a Thermal-Link, which is the maximum voltage that Thermal-link allows to carry and is able to cut off the circuit safely.



## ATTENTION

### Usage

1. When atmosphere pressure is from 80 kPa to 106 kPa, the related altitude shall be from –500 m to 2000 m.
2. Operating voltage less than rated voltage of DC-ATCO, operating current less than rated current of DC-ATCO.
3. Do not touch the DC-ATCO body or lead wires directly when power is on, to avoid burn or electric shock.

### Replacement

DC-ATCO is a non-repairable product. For safety sake, it shall be replaced by an equivalent DC-ATCO from the same manufacturer, and mounted in the same way.

### Storage

Do not store the DC-ATCO at the high temp., high humidity or corrosive gas environment. The product shall be stored at  $25 \pm 5$  °C and  $\leq 70\%$  RH, avoid direct sunlight and shall use them up within 1 year after receiving the goods.

## Installation

Make Sure the Temp. of Installation Position

1. It is recommended that a dummy DC-ATCO with inbuilt thermo-couple shall be used to determine the proper temp.
2. The terminal product should be tested to ensure that potential abnormal conditions do not cause ambient temp. to exceed the  $T_m$  of the DC-ATCO.
3. Mount the DC-ATCO at the location where temp. rises evenly.

Installation position of mechanical performance requirements

1. Ensure that the lead wire is long enough, and avoid actions such as press, tensile or twist.
2. The seal or body of DC-ATCO must not be damaged, burned or over heated.









## Mechanical Connection

### Riveting

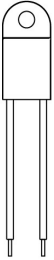

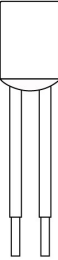

1. Choose small resistivity riveting material and be riveted.
2. A flexible lead or lead with low resistance should be used to rivet the DC-ATCO.
3. Contact resistance should be minimal, Large contact resistance will lead to higher temp., DC-ATCO Functioning in advance.

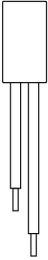

**Direct Current Thermal-Link Alloy Type (DC-ATCO) Features & Model List Overview**

Rated Functioning Temp. ( $T_f$ ) °C	Model								
	TGH187-HVS <sup>^</sup>	ASL187A-LSF <sup>^</sup>	RSK187A-KSS <sup>^</sup>	RVH187-HSF <sup>^</sup>	ARL187-LRA <sup>^</sup>			RQF187-FQS <sup>^</sup>	
230	○	○	○	○	○	○	○	○	○
221	○	○	○	○	○	○	○	○	○
205	○	○	○	○	○	○	○	○	○
200	○	○	○	○	○	○	○	○	○
187	TGH187-HVS <sup>^</sup>	ASL187A-LSF <sup>^</sup>	RSK187A-KSS <sup>^</sup>	RVH187-HSF <sup>^</sup>	ARL187-LRA <sup>^</sup>	○	○	RQF187-FQS <sup>^</sup>	○
160	○	○	○	○	○	○	○	○	○
150	TGH150-HVS <sup>^</sup>	ASL150A-LSF <sup>^</sup>	RSK150A-KSS <sup>^</sup>	RVH150-HSF <sup>^</sup>	ARL150-LRA <sup>^</sup>	RPK150-HRZ <sup>^</sup>	TG150C-HQZ <sup>^</sup>	RQF150-FQS <sup>^</sup>	TG150C-JPZ <sup>^</sup>
145	○	○	○	○	○	○	○	○	○
139	○	○	○	○	○	○	○	○	○
136	TGH136-HVS <sup>^</sup>	ASL136A-LSF <sup>^</sup>	RSK136A-KSS <sup>^</sup>	RVH136-HSF <sup>^</sup>	ARL136-LRA <sup>^</sup>	RPK136-HRZ <sup>^</sup>	TG136C-HQZ <sup>^</sup>	RQF136-FQS <sup>^</sup>	TG136C-JPZ <sup>^</sup>
135	○	○	○	○	○	○	○	○	○
133	○	○	○	○	○	○	○	○	○
130	TGH130-HVS <sup>^</sup>	○	○	RVH130-HSF <sup>^</sup>	○	○	○	RQF130-FQS <sup>^</sup>	○
125	TGH125-HVS <sup>^</sup>	ASL125A-LSF <sup>^</sup>	RSK125A-KSS <sup>^</sup>	RVH125-HSF <sup>^</sup>	ARL125-LRA <sup>^</sup>	RPK125-HRZ <sup>^</sup>	TG125C-HQZ <sup>^</sup>	RQF125-FQS <sup>^</sup>	TG125C-JPZ <sup>^</sup>
123	○	○	○	○	○	○	○	○	○
120	○	○	○	○	○	○	○	○	○
115	TGH115-HVS <sup>^</sup>	ASL115A-LSF <sup>^</sup>	RSK115A-KSS <sup>^</sup>	RVH115-HSF <sup>^</sup>	ARL115-LRA <sup>^</sup>	RPK115-HRZ <sup>^</sup>	TG115C-HQZ <sup>^</sup>	RQF115-FQS <sup>^</sup>	TG115C-JPZ <sup>^</sup>
105	○	○	○	○	○	○	○	○	○
102	TGH102-HVS <sup>^</sup>	ASL102A-LSF <sup>^</sup>	RSK102A-KSS <sup>^</sup>	RVH102-HSF <sup>^</sup>	ARL102-LRA <sup>^</sup>	RPK102-HRZ <sup>^</sup>	TG102C-HQZ <sup>^</sup>	RQF102-FQS <sup>^</sup>	TG102C-JPZ <sup>^</sup>
97	○	○	○	○	○	○	○	○	○
93	○	○	○	○	○	○	○	○	○
86	○	○	○	○	ARL86-LRA <sup>^</sup>	○	TG86C-HQZ <sup>^</sup>	RQF86-FQS <sup>^</sup>	○
76	○	○	○	○	○	○	○	○	○
$I_f$ (A) Rated Current	15	30	25	15	30	15	15	10	20
$U_f$ (VDC) <sup>^</sup> Rated Voltage	850		600		500		450		400
$U_f$ (VAC) <sup>*</sup> Rated Voltage	○	○	○	○	○	○	○	○	○
Product Structure									
	Axial Shape	Radial Shape	Radial Shape	Radial Shape	Axial Shape	Radial Shape	Axial Shape	Radial Shape	Axial Shape

**Direct Current Thermal-Link Alloy Type (DC-ATCO) Features & Model List Overview**

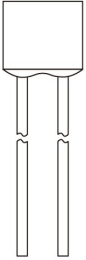
Rated Functioning Temp. ( $T_r$ ) °C	Model												
	TG150C-JSZ*				HN150^*	HP150^*	HS150^*			QD150^A	PD150^A	TD150^A	SD150^A
230	○	○	○	○	○	○	○	○	○	○	○	○	○
221	○	○	○	○	○	○	○	○	○	○	○	○	○
205	○	○	○	○	○	○	○	○	○	○	○	○	○
200	○	○	○	○	○	○	○	○	○	○	○	○	○
187	○	○	○	○	○	○	○	○	○	○	○	○	○
160	○	○	○	○	○	○	○	○	○	○	○	○	○
150	TG150C-JSZ*	○	○	○	HN150^*	HP150^*	HS150^*	○	○	QD150^A	PD150^A	TD150^A	SD150^A
145	○	○	○	○	○	○	○	○	○	○	○	○	○
139	○	○	○	○	○	○	○	○	○	○	○	○	○
136	TG136C-JSZ*	○	○	○	HN136^*	HP136^*	HS136^*	○	○	QD136^A	PD136^A	TD136^A	SD136^A
135	○	○	○	○	○	○	○	○	○	○	○	○	○
133	○	○	○	○	○	○	○	○	○	○	○	○	○
130	○	○	○	○	○	○	○	○	○	QD130^A	PD130^A	TD130^A	SD130^A
125	TG125C-JSZ*	○	○	○	HN125^*	HP125^*	HS125^*	ALP125-PLZ^A	○	QD125^A	PD125^A	TD125^A	SD125^A
123	○	○	○	○	○	○	○	○	○	○	○	○	○
120	○	○	○	○	○	○	○	○	○	○	○	○	○
115	TG115C-JSZ*	○	○	○	ALP115-HLZ^A	○	○	○	○	QD115^A	PD115^A	TD115^A	SD115^A
105	○	○	○	○	○	○	○	○	○	○	○	○	○
102	TG102C-JSZ*	○	○	○	○	○	○	○	ALP102-PLZ^A	QD102^A	PD102^A	TD102^A	SD102^A
97	○	○	○	○	○	○	○	○	○	○	○	○	○
93	○	○	○	○	○	○	○	○	○	○	○	○	○
86	○	TG86C-HSZ*	RPF86-FPF^A	○	○	○	○	○	○	○	○	○	○
76	○	○	○	○	○	○	○	○	○	○	○	○	○
$I_r$ (A) Rated Current	20	15	10	15	15	10	5	60	20	15 16	10	25	
$U_r$ (VDC)^A Rated Voltage	○		400		200			180		125			
$U_r$ (VAC)^* Rated Voltage	600		○	○	690	500		○		○			
Product Structure													
	Axial Shape	Radial Shape			Axial Shape								Radial Shape

**Direct Current Thermal-Link Alloy Type (DC-ATCO) Features & Model List Overview**

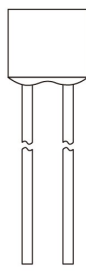
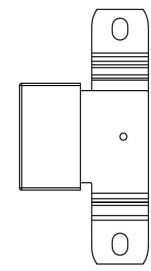
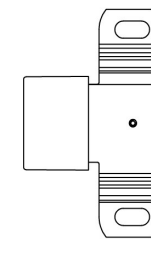
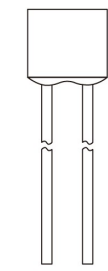
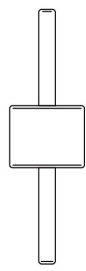
Rated Functioning Temp. ( $T_f$ ) °C	Model													
	Q136**	Q136*	Q136*	P136**	P136*	P136*	TB136-UHZ^A	TB136-UJZ*	TS136-RHZ^A	TS136-RJZ*	S136^A	T136^A	ADN230B-NEZ	
230	○	○	○	○	○	○	○	○	○	○	○	○	○	○
221	○	○	○	○	○	○	○	○	○	○	○	○	○	○
205	○	○	○	○	○	○	○	○	○	○	○	○	○	○
200	○	○	○	○	○	○	○	○	○	○	○	○	○	○
187	○	○	○	○	○	○	○	○	○	○	○	○	○	○
160	○	○	○	○	○	○	○	○	○	○	○	○	○	○
150	○	○	○	○	○	○	○	○	○	○	S150^A	T150^A	○	○
145	○	○	○	○	○	○	○	○	○	○	○	○	○	○
139	○	○	○	○	○	○	○	○	○	○	○	○	○	○
136	○	○	○	○	○	○	○	○	○	○	○	○	○	○
135	○	○	○	○	○	○	○	○	○	○	○	○	○	○
133	○	○	○	○	○	○	○	○	○	○	○	○	○	○
130	○	○	○	○	○	○	○	○	○	○	○	○	○	○
125	○	○	○	○	○	○	○	○	○	○	○	○	○	○
125	Q125**	○	○	P125**	○	○	TB125-UHZ^A	TB125-UJZ*	TS125-RHZ^A	TS125-RJZ*	○	○	○	○
123	○	○	○	○	○	○	○	○	○	○	○	○	○	○
120	○	○	○	○	○	○	○	○	○	○	○	○	○	○
115	Q115**	Q115*	Q115*	P115**	P115*	P115*	TB115-UHZ^A	TB115-UJZ*	TS115-RHZ^A	TS115-RJZ*	S115^A	T115^A	○	○
105	○	○	○	○	○	○	○	○	○	○	○	○	○	○
102	Q102**	○	○	P102**	P102*	P102*	TB102-UHZ^A	TB102-UJZ*	TS102-RHZ^A	TS102-RJZ*	S102^A	T102^A	○	○
97	○	○	○	○	○	○	○	○	○	○	○	○	○	○
93	○	○	○	○	○	○	○	○	○	○	○	○	○	○
86	○	○	○	○	○	○	○	○	○	○	○	○	○	○
76	○	○	○	○	○	○	○	○	○	○	○	○	○	○
$I_r$ (A) Rated Current	25			20			200		100		10	15 16	50	
$U_r$ (VDC)^A Rated Voltage	120						100	○	100	○	100	60		
$U_r$ (VAC)* Rated Voltage	400	300	250	400	300	250	○	125	○	125	○	○		
Product Structure														
							Radial Shape						Axial Shape	



